

**EN**  
2019 v.21

# **/// SUPER 73<sup>®</sup>**



OWNER HANDBOOK  
ASSEMBLY & MAINTENANCE

***SUPER 73 S-SERIES***

# **WELCOME**

**You are now an official member of the SuperSquad.**

We're happy to welcome you into our Super73 rider community.  
Let the adventures begin!

Please read this owner's handbook carefully before using your Super73 in order to become thoroughly familiar with the correct operation of your bike's controls, its features, capabilities, and limitations. This handbook includes safe riding tips, but does not contain all the techniques and skills necessary to ride an electric bicycle safely.

Please make sure you are familiar with the legal rules for electric bikes in your country and state before the first use.

## **Connect with us**

This is just the beginning of our relationship with you! We look forward to hearing about your experience and seeing you online on our social networks:

 [Instagram.com/super73](https://www.instagram.com/super73)

 [Youtube.com/c/super73](https://www.youtube.com/c/super73)

Tip: Use hashtags such as #super73 and tag @super73 and @super73community to get noticed by our community.

Forum: [www.super73owners.com](http://www.super73owners.com) (use your purchase order number to join)

## **CONTACT SUPER73**

SUPER73, Inc.  
16591 Noyes Ave, Irvine, California 92606, United States  
+1 (814) 747-9072

[customercare@super73.com](mailto:customercare@super73.com)  
[www.super73.com](http://www.super73.com)

---

This handbook was drafted in the English language (Original instructions) and may have been translated into other languages as applicable (translation of Original instructions).

This handbook contains information on the Super73 electric bikes. Always store this Owner's Manual with the Super73 and refer to it for information whenever necessary. The information contained in this publication is based on the latest information available at the time of printing.

Please note all instructions and notices are subject to change and updates without notice. Please visit [www.super73.com](http://www.super73.com) for periodic tech updates.

Feedback: [customercare@super73.com](mailto:customercare@super73.com)

This is not to be reproduced wholly or in part without the written permission of Super73. ©Copyright 2019 Super73, Inc., V21. Updated 10/2019 by AFA.



## **TABLE OF CONTENTS**

- 2 Welcome
- 4 Preamble
- 5 General Information
- 6 Legal Requirements
  - Registration
- 7 Intended Use
  
- 8 Diagram of a Super73
- 9 Included tools and hardware
- 10-17 Assembly Instructions
  
- 18 Before the first ride
- 19 Operating the bike
- 20 Lights
  
- 21 Maintenance Schedule
- 22 General Warnings
  - Wet weather
  - Riding at night
  
- 23 Safety / Notes
- 24 Maintenance and Components
  - Tires
  - Helmets
  - Reflectors
  - Brakes
  - Battery
  - Lighting System

# **PREAMBULE**

Super73 electric bikes purchased in Europe and sold for use in Europe (models Super73-SG and SG1) have been tested, certified and are conform to security requirements of EPAC (Electric Power Assisted Cycle) according to EN 15194, have a maximum speed of 25 km/h and a 250 Watt motor power output.

## **Principles of operation of a pedelec:**

Your power assisted bike is "assisted". This means that, according to the legislation, you have to pedal continuously for assistance. The assist is active only during the pedaling movement. The assistance of your bike is cut beyond 25km/h as required by French and European regulations.

For models sold and purchased in the USA, please refer to our website for model types, speeds and power output.

**01/03/2019**

## **NOTICE: 5A BATTERY CHARGER**

If you are unpacking a new SUPER73-S1/SG1 which is supplied with its 5A battery charger to charge the 48V 14.5Ah battery, please note that this 5A charger will not work with previous 48V 14.5Ah models since the charging port is different.

It is only capable of charging the battery supplied in this enclosed SUPER73-S1/SG1 packaging. If you already have a SUPER73-S1/SG1, you'll need to charge its battery using the 5A charger supplied with it. You may be able to get a charging port adapter to connect a new charger to previous battery model. Please contact us or your distributor for more information.

However, all 2A chargers typically supplied with SUPER73-S or SUPER73-SG for 48V 8.8Ah batteries do work with ALL battery models, regardless of generation or date of purchase.

Note: You may also use a previously delivered (before Feb 2019) 5A charger with SUPER73-S or SUPER73-SG (48V 8.8Ah) batteries. It simply charges the battery faster!

If you have any questions or doubt, please contact us directly via phone +1 (814) 747-9072 or e-mail [customercare@super73.com](mailto:customercare@super73.com)

# GENERAL INFORMATION

Carefully read all the instructions that come with this Super73 electric bike, also known as an E-Bike, before the first ride. Please note the following symbols:

 **WARNING!** Warnings, precautions, and potential risks associated with the use of your Super73.

 **Danger!** Possible dangers for your life and health if respective calls to action are ignored.

 **Tip!** Recommendation! Meaningful additional information.

Please perform a safety check before each use, as described on in the “Before your first ride” section of this user guide.

 **We recommend taking your Super73 to a certified E-Bike specialist or bicycle dealer for assembly.**

 **DANGER**  
Do not ride with a bike that has not passed 100% safety verification before each ride as described in the section “Before your first ride”.

Note that explanations of the operations to be performed and tips provided here can, for various reasons, including the experience and skills in the mechanics of the person to execute them, require the use of additional (specific) tools or rely on prerequisites not described in this guide.

 **DANGER**  
This manual includes assembly and maintenance work which may need to be done before a required inspection is due, which needs to be carried out by a specialist dealer. Never perform work on your Super73 beyond instructions in this manual. Do NOT ride your E-Bike if it has been assembled incorrectly. Maintenance beyond what the Owner’s Manual instructs is to be handled by an E-Bike specialist. Riding an incorrectly assembled bike can put your own safety at risk as well as others.

If you feel uncertain about proper configuration after assembling your Super73 according to the provided assembly instructions, please contact your specialized retailer or Super73 directly. We will help you willingly.

# LEGAL REQUIREMENTS



Please check your country or state's regulations on electric bikes before riding. There are variations on age limit, speed, motor wattage and road accessibility. Visit this website for more information: <https://peopleforbikes.org/our-work/e-bikes/policies-and-laws/>

In most European countries and Australia, the rules of public traffic valid for bicycles also apply to e-bikes traveling up to 25 km/h. However, there are some notable differences (such as the age limit of the cyclist). More information here:

<http://bike-eu.com.s3-eu-central-1.amazonaws.com/app/uploads/2015/09/rules-regulation-on-electric-cycles-in-the-european-union-may-2017.pdf>

**For the latest information on assembly and maintenance,  
please go to our website: <https://super73.com/pages/owners>**

## REGISTER YOUR SUPER73



**All original owners must register on our website to validate warranty.**

Please register online at: <https://www.super73.com/pages/register>

If you can't register online, please call us at +1 (814) 747-9072 to have a printed form sent to you. Write down below the following information for future reference:

Location or website of purchase: \_\_\_\_\_

Date of purchase: \_\_\_\_\_

Model name: S-Series

Bike Serial #: \_\_\_\_\_

(Engraved on the side of the bottom bracket in between the pedal cranks)

Battery #: \_\_\_\_\_

Battery Key (if provided): \_\_\_\_\_

We recommend that you keep your original receipt with this handbook.

## **INTENDED USE**

- Your Super73 electric bike is designed for the use on roads and paved paths only. You should therefore never ride on stairs, jump or perform wheelies or similar activities.
- Super73 electric bikes are not approved for participation in competitions.
- Commercial use does not form part of the intended use. Operating, maintenance and service instructions described in this manual are part of the intended use.



No liability or warranty shall be accepted if the use of the Super73 deviates from this intended use, if safety instructions are not observed, in the event of overloading, or if faults are not properly rectified. Similarly, no liability and warranty shall be accepted in the case of assembly errors, willful intent, accidents, and/or if care and maintenance specifications are not followed. Any modification of the gear transmission ratios and alterations to the electrical system (tuning) voids all claims under warranty and guarantees.

- **MAXIMUM LOAD CAPACITY IS 275 LBS (125 KG).**
- Any or all modifications to electronics voids all claims to warranty.



### **DANGER!**

Your E-Bike is only approved to transport a single rider. Follow the regulations applicable to your country. Please observe the permitted overall weight of 275 lbs (125 kg).



### **DANGER!**

If the user rides the Super73 beyond its intended use, there may be a risk of an accident, serious injury or death and the risk of injury to those around the user.

# DIAGRAM OF A SUPER73-S

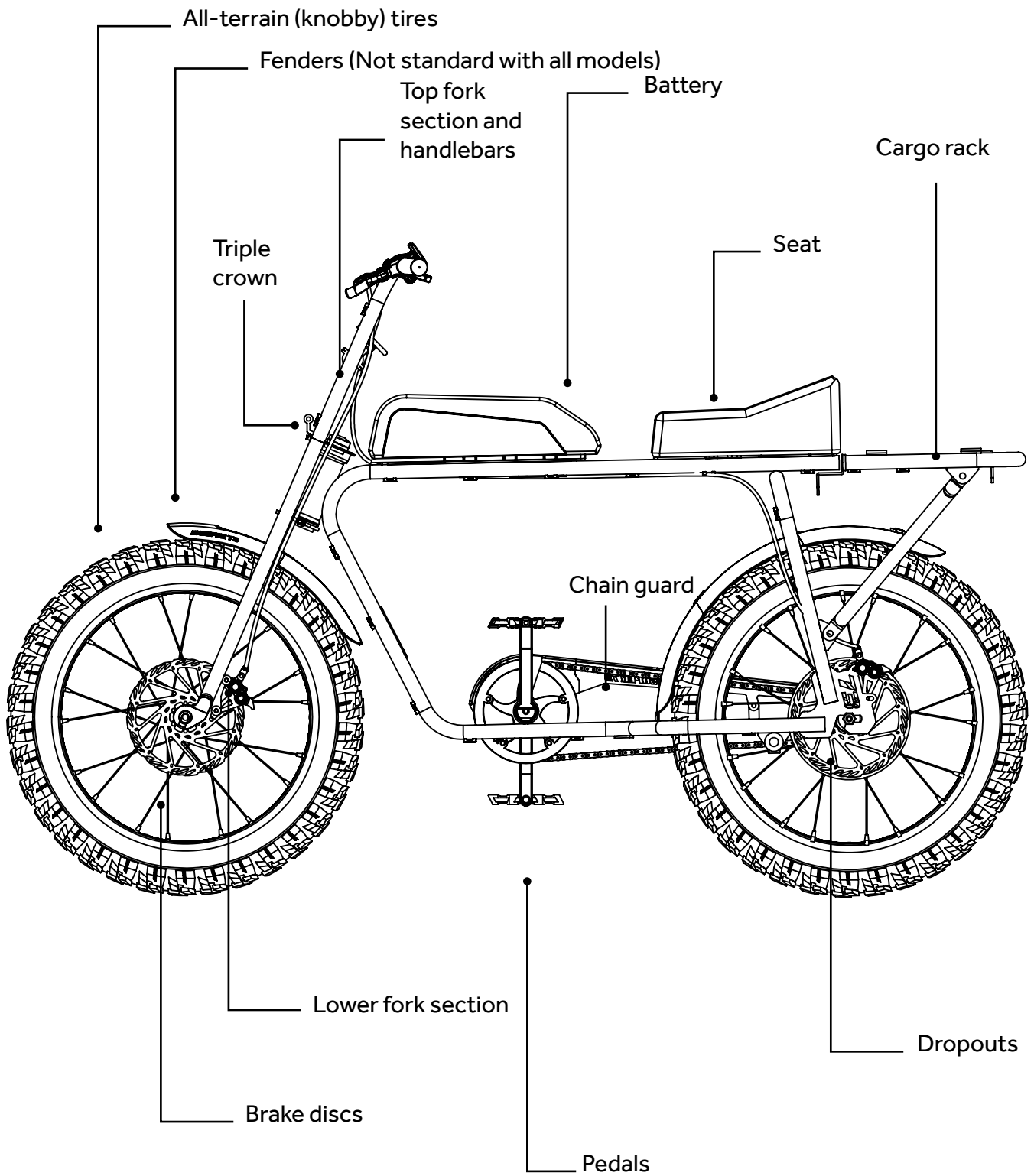



## IN THE PACKAGING

In the packaging, you will find the following tools & hardware:

- 1 x lithium-ion battery
- 2 x keys for the battery
- 1 x battery charger
- 1 x user manual
- 1 x two-sided open end wrench with a 15mm end for pedals and a 13mm end for the fender bolts
- 1 x 5mm Allen key or wrench
- 1 x set of pedals
- 1 x handlebar



### GOOD TO KNOW:

- Bolts for the handlebars mount are M6 X 12mm socket head cap screws
- Right pedal has the letter "R" inscribed on it, the left pedal has the letter "L" inscribed on it.
- 5mm Allen key can also be used to adjust brakes.
- Tire tubes are 20"x4"-1/4" but 20"x4" also work (with Schrader valve)



### DANGER!

Before performing any work on your Super73, turn off the power system and remove the battery. Be sure to also turn off the power system and remove the battery during transport in a vehicle. Involuntary activation of the electrical assistance system presents a risk of injury.



### DANGER!

In this manual, the minimal torques of tightening are indicated in Nm. Do not trust your feeling: even if it looks well fixed, it may not be the case. Only a torque wrench guarantees the exact tightening of the screws. To do this, always use this type of key and respect the torques indicated in this manual. Too little or too tight screws can cause fractures. They can cause falls and serious injuries.



Please note all instructions and notices are subject to change and updates without notice. Please visit <https://super73.com/pages/owners> for periodic tech updates.

# ASSEMBLY INSTRUCTIONS



Needs to be assembled by an e-Bike specialist for warranty.



## VIDEO

View our assembly video to follow step-by-step instructions on our website in the Support section, ([www.super73.com](http://www.super73.com)) or our YouTube channel: [Youtube.com/c/super73](https://www.youtube.com/c/super73)

**LET 'S START:** You'll need a second person to help unpack and assemble your Super73.



## ACTION:

Open the packaging with caution. Unpack your Super73 over a large flat clean area, with a padded or soft surface like carpet to place bike parts without damaging them. Take out all elements in the packaging placing them on a flat surface.

**HARDWARE:** box cutter, scissors, or blade



## DANGER

Please follow the instructions carefully to ensure the proper functioning of the Super73. Failure to do so could result in serious personal injury and / or death.



**2**

**ACTION:** Remove the frame from its packaging. REMOVE THE BATTERY PRIOR TO ASSEMBLY. Stabilize the bike upright on the kickstand. Then, remove the battery off of the controller by sliding it horizontally towards the seat.



## CHARGE THE BATTERY

Remove the battery from the main frame. Two keys are supplied to unlock and lock the battery.

1. Plug in the charger into a regular wall outlet.
2. Connect the charging cable to the battery.
3. Turn on the battery safety switch. The switch should be on the "I" position. The battery will not charge unless it is switched on.

 We recommend charging the battery for 6-8 hours on the first charge. This will help condition the lithium-ion cells for optimal performance.

When the charging process starts, the charger LEDs turns red. Once the battery is charged, the LED turns green. Remove the charger cable from the battery and then unplug it from the socket. Remember to put the protective cap back onto the battery charging socket after charging to protect it from dirt and moisture.

Always make sure there is plenty of ventilation and a dry, fireproof environment for the charger and follow these operating instructions:

- Do not leave the battery connected to the active charger for more than 48 hours.
- Do not leave the charger connected to a socket for more than 48 hours.
- Charge the battery and use the bike at least once every 90 days
- Do not store the bike for more than 24 hours with an empty battery. This prevents a deep discharge with irreparable consequences from occurring.
- Do not use the charger if the charger, main cable or connector cable have any visible signs of damage.
- After being charged, if the battery remains connected to the charger, it will turn on and off again in short spurts of green light. This is not a defect. It simply indicates that individual battery cells are being slowly charged. Nevertheless, make sure that the battery is not connected to the charger for more than 48 hours.

More information on battery care and range in the Maintenance and Components section.



## HANDLEBAR INSTALLATION

- a. Use 5mm Allen key to remove bolts of handlebar clamp.
- b. Once the clamp is open, place the lower cross bar of the handlebar in the groove of the top crown.
- c. Loosely tighten handlebar clamp with Allen key, and adjust it to desired angle.
- d. Tighten handlebar completely.

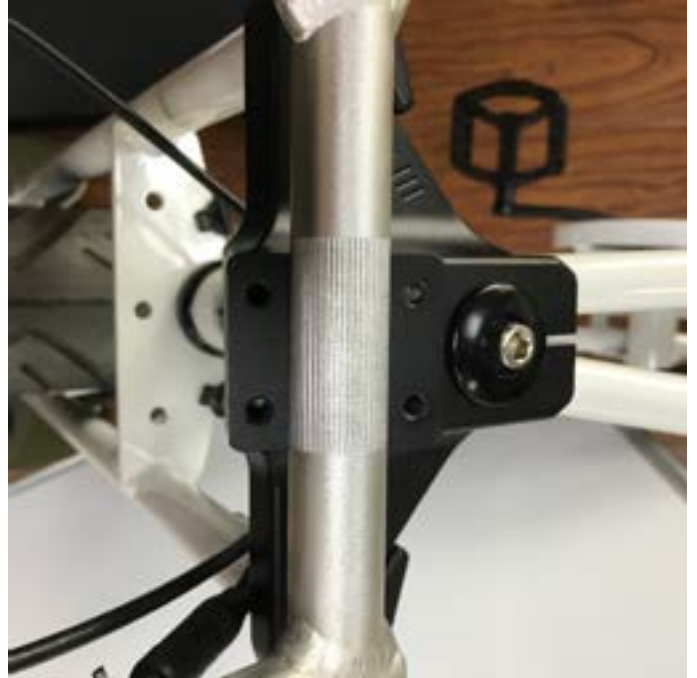

# 4

## CONNECT WIRING HARNESS CABLE

Connect the wiring harness plugs into their corresponding connectors. (RED TO RED, YELLOW TO YELLOW, BLACK TO BLACK)



The pins in these connectors are very sensitive. Line up the arrows to ensure that you do not break the pins.



# 5

## HEADLIGHT ATTACHMENT

**ACTION:** Take the front light and attach the bracket under the top triple clamp using the two provided bolts. Fully tighten the bolts. Next, connect the headlight, matching the yellow headlight plug to the yellow controller plug.

**HARDWARE:** #4 (5mm Hex wrench) and 5mm bolts with washers.



# 6

## DISPLAYS

**ACTION:** Adjust the display to desired angle and tighten. Note: US Displays are on the right side. European Displays are installed on the left side of the handlebars.

**HARDWARE:** #6 (3mm Hex wrench)

**NOTE:** DO NOT INSTALL THE DISPLAY TOO CLOSE TO THE BRAKE LEVER ATTACHMENT, AS THIS MAY CAUSE THE THROTTLE TO STICK AND PREVENT FULL ROTATION OF THE THROTTLE



# 7

## BRAKES

**ACTION:** Adjust the brake levers to desired angle and tighten.

We recommend a 45 degree angle for brakes (hydraulic setup pictured below).

**HARDWARE:** 4mm Hex wrench





**NOTE:** On European models, the brake levers go to the opposite front/rear brake lines. What's important is to keep the headlight cable in between the front and rear brake lines.  
**ACTION:** Place the sensor and motor cables under their corresponding cable guides and zip tie in place.

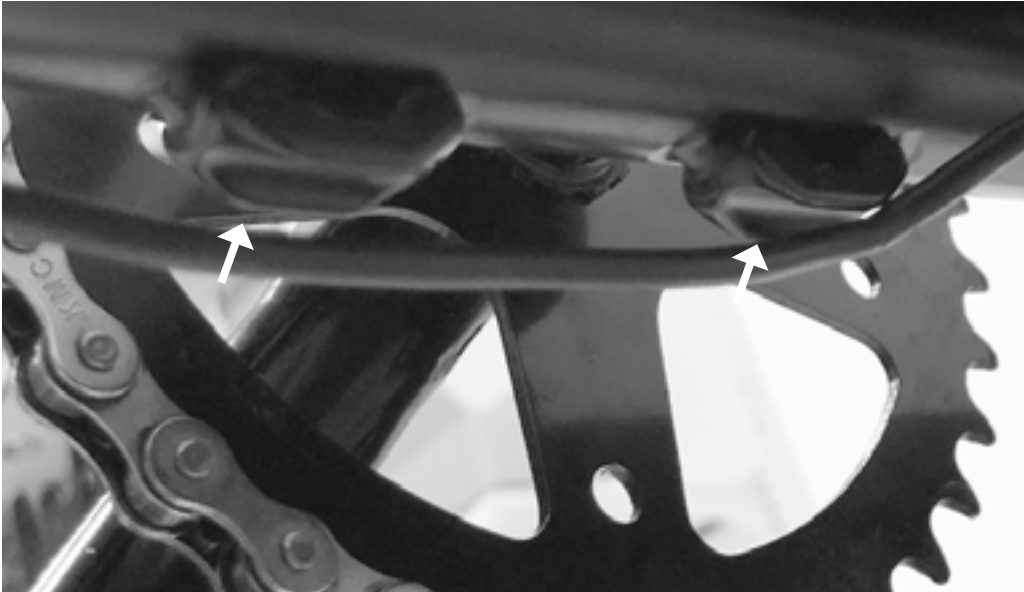

**VERIFICATION:**

The zipties should secure the hard plastic connector portion of the cable (not the soft cable tubing area) in order to protect wires from strain.

The wiring and brake cables should be loose and show no signs of strain when turning the fork in either direction.



Proper configuration of cables with hydraulic brakes.



## PEDAL INSTALLATION

Install and tighten the pedals using the using the 15 mm open wrench. Look for a small L/R on each pedal and make sure you install the left pedal on the left crank, the right pedal on the right crank.

**The right pedal is screwed on in a clockwise direction.**

**The left pedal is screwed on by turning it counter-clockwise.**



## TIRE INFLATION

For transport purposes, tires are packed partially inflated.

Tires must be inflated using a pump with a Schrader valve tip with a recommended pressure of between 20-25 psi, 1.37-1.7 bar.

Check the condition of the tires and rims for damage, cracks or deformation.

Tip: Tubes are 20"x4" - 1/4 but 20"x4" will also work.





## **ASSEMBLY IS FINISHED!**

You're almost ready to ride. Your Super73 should look like below. Before each ride, it is important to do a full system check, such as checking the tightness of all nuts and bolts. Make sure you follow every step in the next section "Before the first ride".



**HAPPY RIDING!**

# ***BEFORE THE FIRST RIDE***



If you have purchased your bike from a specialist dealer, they must provide the electric bike in a condition ready to ride in order to ensure safe operation. The dealer must perform a final inspection and a test ride.



## **DANGER**

Make sure the brakes have already been applied prior to getting on to your bike. If the assistance mode is turned on, your E-Bike will start moving as soon as you push on the pedal. The unfamiliar push can otherwise cause a fall, hazard, or accident.

## **SAFETY CHECK:**

### 1. WHEELS

Check the tires' condition, alignment and air pressure. Check the tires and wheels for damage, cracks and deformation.

### 2. BATTERY

Check that the battery is inserted securely: push the battery into its holder until it clicks into the lock. Remove the key from the lock and pull the battery to check if it has indeed locked into place. Check the charge status of the battery. Familiarize yourself with the functions of all controls.

### 3. BRAKES SYSTEM

Pull both brake levers. You should feel an obvious pressure point and the levers should not be able to touch the handle.

- Make sure that the disks are not rubbing against each other.
- If they do rub at the beginning, it's normal because they are not broken in.
- To learn more about adjusting brakes go on our website, our YouTube channel, or visit your local bike shop to have them professionally adjusted and tuned.

Check that the configuration of the brake lever matches what you are used to. Otherwise your specialist dealer should adjust the configuration of the brake levers. More information on brakes in our Maintenance & Components section of this manual.

4. LIGHTING: Check if the front and rear lights are working properly and if the front light is set correctly. Do not cover lighting and reflectors.

### 5. CABLES: Look out for any loose cables

- Make sure the male and female plugs are properly connected.
- There should be no strain on any wiring near the fork when tuning the handlebars from left to right.
- Verify that the wiring on the frame is secure and free from any moving parts that may damage the wiring. For example, the motor wire should be secure.

6. DISPLAY: Check that your display turns on and functions properly

7. KICKSTAND: Make sure that the kick stand is tightly secured, and not rubbing against the ground or tires. **DO NOT SIT ON A BIKE WITH THE KICKSTAND ENGAGED.**

# OPERATING THE BIKE



## **DANGER**

Batteries that have not been fully inserted and locked can come loose during a ride and fall out. This can cause a crash and damage the battery.



**DANGER** Do not place the key inadvertently or any other metal object into the charging port as this can result in a short circuit and render your battery nonchargeable and in need of replacement. This will void the warranty.

## **1. INSERT THE BATTERY**

- Make sure the battery is fully charged (the LED on the charger should be green).
  - With one hand on the frame, use the other hand to slide the battery horizontally onto the controller on the frame. Push it all the way in until it clicks.
  - Lock it in with the provided key to prevent it from sliding out.
  - Make sure the safety power switch on the side of the battery is on (on the "I" side).
- For information on how to charge the battery, see our section on batteries in our Maintenance and Components section.



## **2. POWER-ON THE DISPLAY**

Disengage kickstand. Seat yourself on the Super73. Turn on the display panel by pressing on the power button for a few seconds (1-3 seconds). Make sure the battery switch is on. The display screen will light up. Throttle is now live.



## **3. SET YOUR LEVEL OF PEDAL ASSIST**

To select your level of pedal assist, press on the "M" button or the UP and DOWN arrow, depending on your display. You have 3-5 levels of pedal assist (depending on model).

Basic overview of pedal assist settings:

THROTTLE ONLY - No pedal assist.

You can pedal without the motor on at 100% speed

ECO - 20% of speed power

MED/TOUR - 60% of speed power

HIGH/SPORT - 100% of speed power

The higher the level, the more electric assistance you'll get, and the less you'll have to pedal. For instructions on how to adjust the display settings, please visit our support page on our website: [www.super73.com/pages/owners](http://www.super73.com/pages/owners)

## 4. TURNING ON THE LIGHTS

To turn on your headlight and rear lights, if you have a US bike model, tap the light/power button  once. Do the same to turn them off.

If you have a European bike model, press on the up arrow  to turn the lights on and off.



*Rear brake lights*



*US model display*



*European model display*

## TURNING OFF YOUR BIKE

When you are done riding your Super73 it is important to turn off the power properly.

1. Turn off the display panel by pressing the power  button for a few seconds.
2. Turn off the battery by pressing the safety switch on the side of the battery.

The switch should be on the "O" position.

3. You can charge the battery while it's on the Super73, or remove it from the controller and charge it separately.

## THE FIRST RIDE

### Riding off-road (sand, gravel, dirt, uneven terrain)

Please note that the Super73 is designed primarily for riding on flat, paved roads. Riding on any other surfaces including sand, grass, gravel, dirt, rocks, or various uneven terrain may significantly decrease battery life and motor performance.

### Battery Range

Power output will vary depending on battery capacity. If your battery is at 20%, for example, it won't have as much power as a fully charged battery. If your Super73 has been shipped to you along with the battery, please fully charge the battery first. When a battery leaves the factory, it's not fully charged as required by air freight legislation. Battery is fully charged when the LED light on the charging cable converter is green.

More information on range and performance in Maintenance and Components section of this manual.

### **DANGER**

If the user rides the Super73 in situations beyond its intended use, there may be a risk of an accident, serious injury or death and the risk of injury to those around the user.

# ***MAINTENANCE SCHEDULE***

In order to prolong the life expectancy of your bike, here is an example of a maintenance schedule, in the case of regular use, that we recommend following:

1. Before & after each outing
  - Check the brakes
  - Check the tire pressure and any damage
  - Check the alignment of the wheels
  - Check that the battery is locked on the frame
  - Store your bike carefully in a clean and dry place
  - Check that your kickstand is tightly secured
  - Check for loose wires
  - Charge your battery
  
2. Every month
  - Inspect the possible presence of play in the steering tube
  - Check the cables, tires, handles
  - Check the wear of discs, brake pads, replace them if necessary
  - Check the sail of the wheels, the tension of the spokes
  
3. Every six months (depending on frequency, and type of use)
  - Inspect the frame, fork and look for signs of cracks in the metal.
  - Check the play of the bottom bracket.
  - Check and grease the wheel hubs, headset, all parts in friction.

For a more efficient control, it is advisable to go to your authorized dealer, in order to make a thorough check. For your own safety, take your E-Bike for its first inspection with your specialist dealer after 200 to 400 km (125 to 250 miles) or at the latest after three months.

## **WASHING AND CARING FOR YOUR BIKE**

Sweat, dirt and salt from winter road maintenance or sea air can damage your bike. You should therefore regularly clean your Super73 and protect it against corrosion. Use clear water for cleaning and a little bit of soap if necessary to dissolve grease residues. Do not spray water directly onto your Super73. Instead, use a lightly damp cloth to wipe down any dirt or debris. After drying your bike, treat surfaces with a care product. Finally, wipe all parts with a clean, soft cloth.



### **ATTENTION!**

Do not clean your Super73 with a strong water jet or steam jet from a short distance. The water can get passed the seals and get inside the bearings. Lubricants are diluted, increasing friction. In the long run, the bearing surfaces will deteriorate.



### **DANGER**

Intensive use of the Super73 may cause possible damage to the frame and the fork. It is important to inspect the frame and the fork and look for signs of cracks. A broken or cracked frame and fork can cause a fall, danger or accident.

# GENERAL WARNINGS

Like any sport, cycling involves risk of injury and damage. By choosing to ride a bicycle, you assume the responsibility for that risk. You need to know and practice the rules and safety regulations of riding this bicycle. Proper use and maintenance of your bicycle reduces risk of injury. Check your local state or country regulations for electric bike laws. For example, check the minimum age for using an electric bike as this differs in various regions.

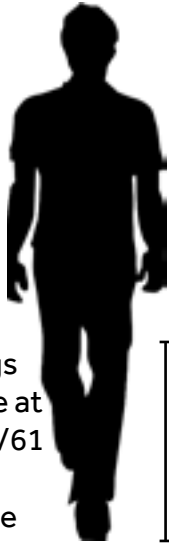

Users legs should be at least 24"/61 cm long to ride the Super73.

Riders must have the physical condition, reaction time and mental capability to ride and manage traffic, road conditions, and sudden situations. Also, respect the laws governing E-bike use with accordance to each region. If you have an impairment or disability (i.e. visual impairment, hearing impairment, physical impairment, cognitive/language impairment, seizure disorder, etc.), consult your physician before riding any bicycle.

**NOTICE:** It is recommended that users pay special attention to all of the general operating rules below before operating their Super73 bike.

- When riding, obey the same road laws as all other road vehicles, including giving way to pedestrians and stopping at red lights and stop signs.



- For additional information, contact the road traffic authority, police department or Department of Motor Vehicles in your state or country.
- Use correct hand signals to indicate turning or stopping.
- Concentrate on the path ahead. Avoid potholes, gravel, wet or oily roads, curbs, train tracks, speed bumps, drain gates, and other obstacles.
- Walk your bike across all train tracks
- Expect the unexpected, such as opening car doors or cars backing out of driveways.
- Be aware at intersections and when preparing to pass other vehicles or other cyclists.
- Familiarize yourself with all the bike features. Practice using the brakes and power system.
- If you are wearing loose pants, secure the bottom using leg clips or elastic bands to prevent them from being caught in the chain or gears.
- Wear proper riding clothes and avoid wearing open toe shoes.
- Don't carry passengers or cargo that will interfere with your ability to control the bicycle.
- Don't use items that may restrict your hearing.
- Maintain a comfortable stopping distance from all other objects, riders, and vehicles. Safe braking distances are based on forces, such as weather and light conditions among other variables.

## WET WEATHER

It is recommended to not ride in wet weather. The Super73 is not meant for use in puddles, heavy rain, and streams. Never immerse this product in water as the electrical system may be damaged. Take extra care while riding in wet conditions. Feet or hands can slip in wet conditions and lead to death or serious injury from a fall. Brake earlier as it will take longer to slow than when operated in dry conditions. Decrease riding speed. Wear reflective clothing and use approved safety lights. Road hazards are more difficult to see when wet, proceed with caution.



## RIDING AT NIGHT

Be safe! It is recommended to not ride at night. Ensure your Super73 is equipped with a full set of correctly positioned and clean reflectors. Use a properly functioning lighting set comprised of a white front lamp and red rear lamp. Wear reflective and light colored clothing. Slow down and use familiar roads with street lighting, if possible.



A NOTE FOR PARENTS AND GUARDIANS As a parent or guardian, you are responsible for the activities and safety of your child. The Super73 is not designed for use by children.

**ATTENTION!**

Only take on tasks for which you have the necessary knowledge and tools.



## ***SAFETY NOTES***



The following safety notes provide additional information on the safe operation of your Super73 and should be closely reviewed. Failure to review these notes can lead to serious injury or death.



- All users must read and understand this manual before first use. Additional manuals for components used on your bicycle may also be provided and should be read before use in addition to this manual.
- Always wear an approved bicycle helmet whenever using this product and ensure that all helmet manufacturer instructions are used for fit and care of your helmet. Failure to wear a helmet when riding may result in serious injury or death.
- Ensure correct tightening and setup is performed on your bicycle before purchase and is checked regularly.



- It is your responsibility to familiarize yourself with the laws and requirements of operation of this product in the area(s) where you ride.
- Ensure handle bar grips are not damaged and properly installed. Loose or damaged grips can cause you to lose control and fall.
- Off-road riding requires close attention and specific skills and presents variable conditions and hazards which accompany the conditions. Wear appropriate safety gear and do not ride alone in remote areas.
- Bicycles and bicycle parts have strength and integrity limitations and extreme riding should not be performed or you risk damaging the components or becoming seriously injured or killed.
- After any incident you must consider your bike unsafe to ride until you consult with a certified bicycle service provider for a comprehensive inspection.
- Failure to properly charge, store or use your battery will void the warranty and may cause a hazardous situation.
- Extreme care should be taken when using the pedal assist sensor and propulsion on this product. Ensure you understand and are prepared for the power assistance to engage as soon as pedaling is underway.
- You should check the operation of the brake inhibitor switches before each ride. The brake system is equipped with an inhibitor which shuts down the power to the electric motor whenever the brakes are engaged.
- User must understand the operation of the twist thumb throttle and pedal assist sensors before using, and take ample care in their usage at speeds appropriate for each region and user experience level. Use the lowest assist level until you are comfortable with the bike and feel confident in controlling the power.
- Because e-bikes are heavier and faster than normal bicycles, they require extra caution and care while riding.
- Do not remove front, rear or pedal reflectors.
- Be familiar with your local e-bike laws.
- Any after-market changes to your Super73 bike not expressly approved by Super73 could void the warranty and create an unsafe riding experience.



# MAINTENANCE & COMPONENTS



## **DANGER**

Before performing any work on your Super73 electronics system, turn off the system and remove the battery. Involuntary activation of the Super73 system poses a risk of injury.



## **TIRES / WHEELS**

The Super73 has 20" x 4.25" (51 x 10.7 cm) rubber tires with inner tubes and a tube liner. The tires are designed for durability and safety for regular cycling activities. However, tires must be checked before each use for proper inflation and condition.

Proper inflation, good maintenance and quick replacement will help ensure that the operational characteristics of your bike will be maintained and dangerous conditions avoided.

Tires must be inflated using a pump with a Schrader valve tip with a recommended pressure of between 20 and 25 psi (1.37 and 1.7 bar). Check the condition of the tires and rims for damage, cracks or deformation a recommended pressure of between 20 and 30 psi (1.37 and 2 bar). The minimal tightening torque of the wheels is 25 ft/lb or 33.89 N m.

It is essential that the proper air pressure is maintained in the tires all the time. Do not under-inflate or over-inflate your tires. Low pressure can cause loss of control and tires that are too inflated can burst. Failure to maintain the air pressure rating indicated on the tires may at any time result in tire and / or wheel failure.

Inflate your tires from a regulated air source with an available manometer. Inflating your tires with an unregulated air source could over-inflate them, resulting in an exploded tire. When tire wear becomes obvious or a hole in the tire is found, you must replace the tires and / or tubes before using the bike, otherwise injury to operators and / or damage to your bike could occur.

To avoid serious injury, make sure all air pressure has been removed from the inner tube before removing the tire from the rim. In addition to proper inflation, correct wheel alignment helps to decrease tire wear. If you find a tire is worn unevenly, have your dealer check the wheel alignment.



**CHAIN TENSION:** There should be approximately one half inch of movement in the chain up and down at a point half way between the front and rear sprockets. To change the tension loosen one of the axle-nuts and move the wheel forward or backward slightly and tighten it up again.

## **HELMETS / REFLECTORS**



A properly fitting ANSI or SNELL, (or CE if you are located in Europe), approved bicycle safety helmet should be worn at all times, when riding your bicycle, or recommended per your local laws. Always wear a properly fitted helmet which covers the forehead when riding a bicycle. Many states require specific safety devices. It is your responsibility to familiarize yourself with the laws of the state where you ride and to comply with all applicable laws, including properly equipping yourself and your bike as the law requires.

Reflectors are important safety devices which are designed as an integral part of your bicycle. Federal regulations require every bicycle to be equipped with front, rear, wheel, and pedal reflectors. These reflectors are designed to pick up and reflect street-lights and car lights in a way that helps you to be seen and recognized as a moving bicyclist. Check reflectors and their mounting brackets regularly to make sure they are clean, straight, unbroken and securely mounted.





## **DANGER**

We recommend using our recommended brand of spare parts, or the original manufacturer parts for replacement of used components.

## **BRAKES**

For optimum braking performance, Super73 bikes are equipped with Tektro mechanical or hydraulic disc brakes. See video on our website on how to adjust: [www.super73.com/pages/owners](http://www.super73.com/pages/owners) or Tektro brake adjustment manuals on [www.tekro.com](http://www.tekro.com).

The Super73 bikes are assembled as follows:

**For North America: front brake = right lever, rear brake = left lever**

**For Global/EU: front brake = left lever, rear brake = right lever**

Using the same disc, braking performance is similar between a mechanical or hydraulic disc brake, but there are some differences in operation:



On a hydraulic disc brake, pad wear is compensated automatically. Simply check the alignment of the pads with the disc, and check that the wheel is fully pushed back. Good alignment ensures the absence of noise and a normal wear of the pads.



The wear of the pads on a mechanical disc brake can be regulated by unscrewing the cable tension knob. There is a complementary adjustment of the inner pad which can be tightened closer or removed from the disc by screwing it in or out with a 5 mm Allen key.

To ensure maximum service life of the brake components, avoid contamination of the pads and the disc by greasy substances.

Regularly check the condition of your cables, ducts or harness and the wear of your pads. Some discs are only compatible with "resin" pads. Do not use a metal pad with discs marked "Resin".

For better ergonomics and safety, we advise you to adjust the brake levers in a position that places it as a natural extension of the user's arms. If you have any questions or concerns, please contact your retailer.



### **Break-in period**

Disc brakes have a 30-40 miles break-in period to achieve optimal pad seating and performance. Exercise caution for the first 30-40 miles each time you replace the brake pads. If you notice a squeal-like sound at the beginning, it's normal. The brakes are naturally adjusting. Depending on the frequency of use, you may need to replace the brake pads.



### **Replacing the pads**

When pads are worn, make sure to adjust both clearances between the rotor and pad so that they are equal to 0.3 mm. If only one side is adjusted it will cause braking failure.

1. Pads and pad holders are held in place by a 3 mm pad retainer bolt on the caliper. To remove the pads and pad holder, unscrew the retainer bolt, then gently push out the pads and holder. This may be easier to achieve by using the Allen wrench.
2. Once free of the caliper, the pads may be easily removed from the pad holder.

## Warning

Do not adjust the cable tension only to compensate pad wear. After you replace with new pads, check to see if the rotor and pads have contact with each other. If so, go back to step 1 and 2 to adjust until a 0.3 mm clearance is visible.

## The Tektro warranty

Super73 brakes are from the Tektro brand. For any manufacturing problem or question related to Tektro brakes, you can contact the local Tektro representative. The contact details of the distributors and places of services: <http://www.tektro.com/service-a.php?t=2>



## BATTERY

The battery is the most important component on your Super73. Following a few simple rules, you can optimize its life. Here are a few tips :

- Do not store a discharged battery. It could go into deep discharge which will reduce its life.
- Make it a habit to recharge at the end of each ride, so your bike will always be ready to go again.
- Even if it can withstand storage temperatures of 14°F to 104°F (-10°C to 40°C), you can optimize its shelf life by storing it at room temperature 68°F (20°C).
- Observe operating conditions between 23°F to 104°F (-5°C to 40°C).
- Do not leave your battery exposed to high temperatures or direct sunlight for long periods of time (for example, on the back of a car in direct sunlight).
- Please ensure that the contacts are always clean and do not insert metal objects.
- Do not dispose the battery in your trash. There are proper disposal methods for lithium-ion batteries. Please check your local waste management regulations.
- Warning: Lithium-ion battery transportation is subject to certain rules.

## RANGE

The maximum range of a full charge depends on many variables such as: age of battery, type of terrain and incline, rider weight, speed, outside temperature, driving style, amount of pedaling, or tire inflation.

### Conditions that affect your battery's range:

- Temperature: Extreme cold and heat can affect the batteries capacity.
- Total Number of Charge Cycles: As the battery ages, total capacity can decrease. The battery has a total of 1000 full cycles when it's new.
- Wind: Riding into a strong headwind can decrease range.
- Road Conditions: Excessively rough or hilly terrain requires the consumption of more power.
- Load: Carrying extra weight on the bike or in a backpack will use more energy.
- Operator Weight
- Repeated Acceleration from a standing start.
- Proper Gear Usage: Taking full advantage of the available gear will significantly increase range.
- Poor Maintenance: Under inflated tires, mis-adjusted brakes, a dry or dirty chain, can decrease range.

### Range in cold weather:

- In case of extreme cold, the range of your electric bike is reduced. It is a normal physical process, and in no case a damage or defect of the battery. If you use your battery when temperatures rise, its energy will increase again.
- We advise you to store the battery and charge it at room temperature during cold days and to use

your E-Bike immediately after installing the battery. The power consumption warms the battery and you benefit from a good battery life, even when it is cold outside.

- In winter however, plan for shorter trips or pedal with a lower level of assistance.

### Tips for Maximizing Range:

- Charge the battery at room temperature (20°C, 3°-74°F)
- Lithium-ion batteries have no chemical memory, and it is not necessary to discharge the battery completely for best performance. Charging a partially full battery will have no negative effects.
- Maintain proper tire pressures and lube the chain regularly.
- Operating temperatures between 4°C and 30°C (40°F and 85°F) will significantly increase range.
- Get your bike a regular tune up (every 6 months) at your local bike dealer.



**DANGER !** Never charge or use a defective battery. Never send a battery by postal mail by yourself! A battery is in the category of hazardous/dangerous goods. Under certain conditions, the battery may overheat and ignite.



#### TIP!

Please follow proper charging instructions before charging the battery. To charge the battery, use only the original charger or charger approved by the manufacturer. Remove the battery from the charger and disconnect the charger from the power when charging is complete.



**DANGER!** Never charge the battery in a flammable environment. For safety reasons, the charger and the battery must be placed on a dry, non-flammable floor.



#### CAUTION!

Do not open the battery. There is a risk of short circuit. Opening the battery will void the warranty. Protect the battery against mechanical damage, heat (in case of prolonged exposure to sunlight), fire and immersion in water. There is a risk of explosion. In case of damage and improper use of the battery, vapors may emanate. Keep children away from the battery.



#### DANGER !

For the correct and safe operation of the electric motor of your E-Bike, you must have it checked by your dealer as part of a regular inspection. Immediately remove the battery from the E-Bike if you notice damage to the electrical system and visit your authorized dealer for repairs. Please contact your dealer if you have questions, problems or damage. Any lack of professional expertise can cause serious accidents.

## LIGHTING SYSTEM

The lighting system is wired into the main harness of the electric bike. For replacement, you must disconnect the cables on both the rear brake light and front light and get new parts. There are no batteries in the lights. Make sure the front and rear lights are clean before riding. If they are dusty, or dirty, clean them with a damp cloth for optimal visibility.

## SEAT

It is not possible to adjust the seat height of the Super73. It is fixed to the frame by bolts. The minimum seat clamping torque on the frame is 6.78 (Nm) 5lb / ft.

For maintenance, use a cloth and water with a little soap to clean it. Avoid leaving the seat too long in the sun, as the fabric can soften and be punctured more easily. Avoid wearing clothes that could catch on the fabric and puncture it.



## **DANGER!**

The bike is subject to wear and is highly stressed, like all mechanical parts. Materials and parts react differently to wear and abrasion. If the intended life of a part is exceeded, it is possible that it will suddenly fail, which represents a certain danger for the cyclist. Any type of cracks, streaks or color changes in highly stressed areas indicate the maximum wear of a part. It must therefore be replaced immediately.

It is important to use original, genuine parts for safety-critical components for the replacement of worn parts.

## **WARRANTY**

Each new Super73 comes with a manufacturer's warranty for the original retail purchaser. Please revert to your dealer or distributor for warranty information, or visit our website:  
<https://super73.com/pages/return-policy>

## **HAVE YOU REGISTERED YOUR SUPER73?**

We recommend all original owners to register their purchase on our website.

Please go to: [www.super73.com/pages/register](http://www.super73.com/pages/register)

If you are unable to go on the internet, please give us a call at +1 (814) 747-9072 and we'll help you register your Super73.